

**EverFlo™
EverFlo™ Q**

USER MANUAL | BEDIENUNGSHANDBUCH

RESPIRONICS
1001 Murry Ridge Lane
Murrysville, PA 15668
www.respironics.com



Respironics Deutschland
Gewerbestr. 17
82211 Herrsching, Germany



0123

1053621
DSF-4/16/08
EN, DE

EverFlo / EverFlo Q User Manual

Table of Contents

| | |
|--|-----------|
| Symbol Key | 2 |
| Abbreviations..... | 2 |
| Chapter 1: Introduction..... | 3 |
| Intended Use..... | 3 |
| About Your EverFlo / EverFlo Q..... | 3 |
| Parts of Your Concentrator | 3 |
| Accessory Equipment and Replacement Parts | 3 |
| Warnings and Cautions | 4 |
| Chapter 2: Operating Instructions..... | 5 |
| Chapter 3: Cleaning & Maintenance | 7 |
| Cleaning..... | 7 |
| Service | 7 |
| How to Contact Respirationics..... | 7 |
| Chapter 4: Alarms and Troubleshooting | 8 |
| Troubleshooting Guide | 9 |
| Chapter 5: Specifications..... | 10 |
| Appendix A: EMC Information | 12 |
| Limited Warranty | 14 |

EverFlo / EverFlo Q User Manual

Symbol Key



Follow Instructions for Use



Type BF Applied Part



Class II equipment



No smoking



No oil or grease



Do not disassemble



General Alarm



European Declaration of Conformity



Canadian/US Certification



AC Power

REF

Model Number

SN

Serial Number



On (Power)



Off (Power)

IPX1

Drip proof equipment



Action Required, Check System Notification



Compliant with the Waste Electrical and Electronic Equipment/Restriction of the Use of Certain Hazardous Substances in Electrical and Electronic Equipment (WEEE/RoHS) recycling directives

Abbreviations

| | |
|-----|-----------------------------|
| LED | Light Emitting Diode |
| LPM | Liters per Minute |
| OPI | Oxygen Percentage Indicator |

EverFlo is a trademark of Respironics, Inc. and its affiliates.
© 2008 Respironics, Inc. and its affiliates. All rights reserved.

Chapter 1: Introduction

Your health care professional has determined that supplemental oxygen is of benefit to you and has prescribed an oxygen concentrator set at a specific flow setting to meet your needs. **DO NOT** change the flow settings unless your health care professional tells you to do so. Please read and understand this entire manual before using the device.

Intended Use

The EverFlo / EverFlo Q Oxygen Concentrator is intended to provide supplemental oxygen to persons requiring oxygen therapy. The device is not intended to be life supporting or life sustaining.

About Your EverFlo / EverFlo Q

The device produces concentrated oxygen from room air for delivery to a patient requiring low flow oxygen therapy. The oxygen from the air is concentrated using a molecular sieve and a pressure swing adsorption process. Your home care provider will show you how to operate the concentrator and will be available to answer any questions. If you have additional questions or problems, contact your home care provider.

Parts of Your Concentrator

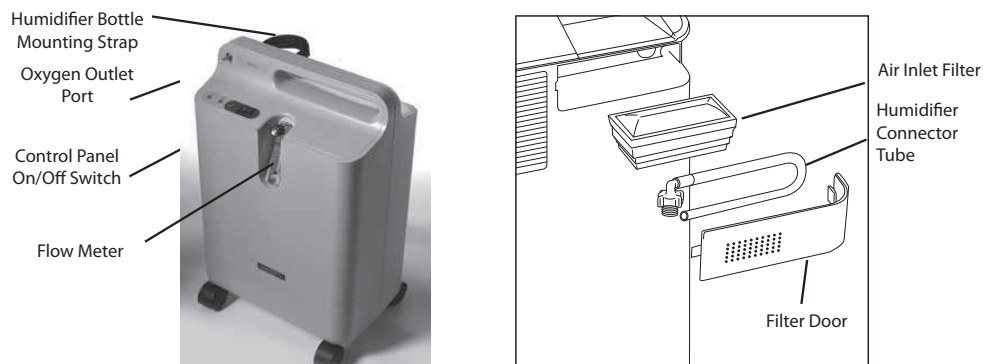

Accessory Equipment and Replacement Parts

Contact your home care provider if you have questions about this equipment. Use only the following Respiration accessories and replacement parts with this device:

- Air Inlet Filter
- Humidifier Connector Tube

Warnings and Cautions

Warnings

A warning represents the possibility of harm to the operator or patient.

- For proper operation, your concentrator requires unobstructed ventilation. The ventilation ports are located at the rear base of the device and at the side air inlet filter. Keep the device at least 15 to 30 cm away from walls, furniture, and especially curtains that could impede adequate airflow to the device. Do not place the concentrator in a small closed space (such as a closet).
- Do not remove the covers of this device. Servicing must be referred to an authorized and trained Respironics home care provider.
- In the event of an equipment alarm or if you are experiencing any signs of discomfort consult your home care provider and/or your health care professional immediately.
- Oxygen generated by this concentrator is supplemental and should not be considered life supporting or life sustaining. In certain circumstances oxygen therapy can be hazardous; any user should seek medical advice prior to using this device.
- Where the prescribing health care professional has determined that an interruption in the supply of oxygen, for any reason, may have serious consequences to the user, an alternate source of oxygen should be available for immediate use.
- Oxygen vigorously accelerates combustion and should be kept away from heat or open flame. Not suitable for use in the presence of a flammable anesthetic mixture with air or with oxygen or nitrous oxide.
- Do not smoke, allow others to smoke or have open flames near the concentrator when it is in use.
- Do not use oil or grease on the concentrator or its components as these substances, when combined with oxygen, can greatly increase the potential for a fire hazard and personal injury.
- Do not use the oxygen concentrator if either the plug or power cord is damaged. Do not use extension cords or electrical adapters.
- Do not attempt to clean the concentrator while it is plugged into an electrical outlet.
- Device operation above or outside of the voltage, LPM, temperature, humidity and/or altitude values specified may decrease oxygen concentration levels.
- Your home care provider is responsible for performing appropriate preventive maintenance at the intervals recommended by the device manufacturer.

Cautions

A caution represents the possibility of damage to the equipment.

- Do not place liquids on or near the device.
- If liquid is spilled on the device, turn the power off and unplug from electrical outlet before attempting to clean up spill. Call your home care provider if device does not continue to work properly.

Chapter 2: Operating Instructions

Warning: Do not use extension cords or electrical adapters.

1. Select a location that allows the concentrator to draw in room air without being restricted. Make sure that the device is at least 15 to 30 cm away from walls, furniture, and especially curtains that could impede adequate airflow to the device. Do not place the device near any heat source.
2. After reading this entire manual, plug the power cord into an electrical outlet.
3. Do either Step A or Step B below.
 - A. If you are not using a humidifier, connect your nasal cannula to the Oxygen Outlet Port, as shown in the top illustration on the right.
 - B. If you are using a humidifier, follow the steps below:
 1. Open the filter door on the back of the device as shown.
 2. Remove the humidifier connector tube from the back of the filter door and replace the filter door, as shown.
 3. Fill your humidifier bottle according to the manufacturer's instructions.
 4. Mount the filled humidifier on the top of the EverFlo / EverFlo Q device inside the velcro strap, as shown in the illustration on the right.
 5. Tighten the velcro strap around the bottle and secure it so it is held firmly in place.
 6. Connect the humidifier connector tube (that you retrieved from the filter door) to the Oxygen Outlet Port (as shown in Step 3-A above).
 7. Connect the other end of the humidifier connector tube to the top of the humidifier with the elbow in the tubing facing the front, as shown here.
 8. Connect your cannula to the humidifier bottle according to the humidifier bottle manufacturer's specifications.

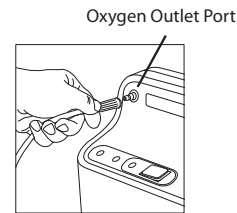

Step 3-A

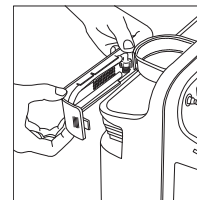

Step 3-B1

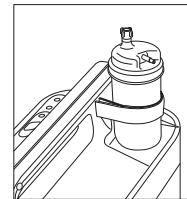

Step 3-B4

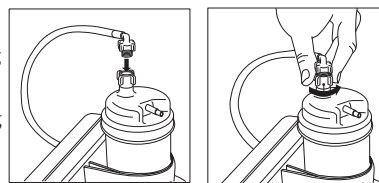

Step 3-B7

EverFlo / EverFlo Q User Manual

4. Press the power switch to the On [I] position. Initially, all the LEDs will illuminate and the audible alert will beep for a few seconds. After that time, only the green LED should remain lit. You can begin breathing from the device immediately even though it typically takes 10 minutes to reach oxygen purity specifications.

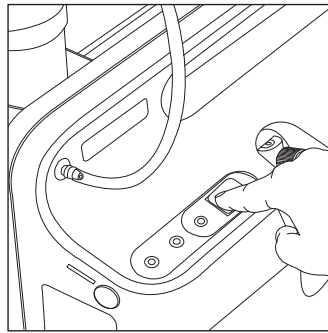

5. Adjust the flow to the prescribed setting by turning the knob on the top of the flow meter until the ball is centered on the line marking the specific flow rate.

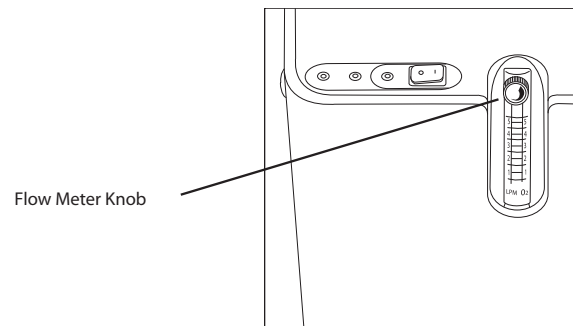

6. Be sure oxygen is flowing through the cannula. If it is not, refer to the Troubleshooting Guide in this manual.
7. Put on the cannula as directed by your home care provider.
8. When you are not using the oxygen concentrator, press the power switch to the Off [O] position.

Chapter 3: Cleaning & Maintenance

Warning: It is important to unplug the device before you perform any cleaning.

Caution: Excess moisture may impair the proper operation of the device.

Cleaning

Periodically, use a damp cloth to wipe down the exterior case of the EverFlo / EverFlo Q device. If you use medical disinfectants, be sure to follow the manufacturer's instructions.

If you are using a humidifier, clean your device according to your home care provider's or manufacturer's instructions.

Service

The EverFlo / EverFlo Q Oxygen Concentrator contains no user-servicable parts.

Warning: Do not remove the covers of this device. Servicing must be referred to an authorized and trained Respironics home care provider.

How to Contact Respironics

To have your device serviced, contact your home care provider. If you need to contact Respironics directly, call the Respironics Customer Service department at 1-724-387-4000 or Respironics Deutschland at +49 8152 93060. You can also use the following addresses:

Respironics
1001 Murry Ridge Lane
Murrysville, PA 15668
USA

Respironics Deutschland
Gewerbstrasse 17
82211 Herrsching
Germany

Visit the EverFlo web site at: www.everflo.respironics.com

Chapter 4: Alarms and Troubleshooting

Alarm and Indicators

The device has an audible alarm and three LED indicators, as shown below.

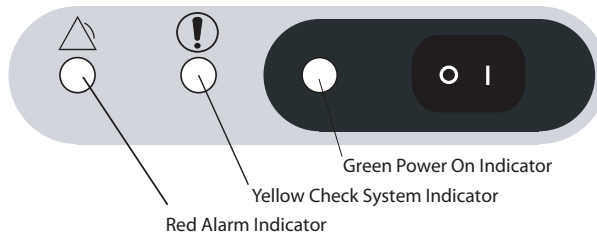

| Audible Alarm / Colored LED | Possible Cause | Your Action |
|---|---|--|
| All 3 LEDs illuminate continuously and the Audible Alarm is sounding continuously. | The device has detected a system malfunction. | Immediately turn off the device, connect to a back up oxygen source, and call your home care provider. |
| The Audible Alarm is sounding continuously. None of the LEDs are illuminated. | The device is turned on but is not operating. Often this indicates that the device is not plugged in or there is a power failure. | Check the power outlet and verify that the device is plugged in. If the problem continues, connect to a back up oxygen source and call your home care provider. |
| Red LED illuminates continuously and the Audible Alarm is sounding continuously. | The device has detected a system malfunction. | Immediately turn off the device and wait 5 minutes. Restart the device. If the condition persists turn the unit off, connect to a back up oxygen source, and call your home care provider. |
| Yellow LED illuminates continuously. The Red LED is blinking and the Audible Alarm is beeping periodically. | The device has detected an impeded oxygen flow condition. | Follow the troubleshooting guide on the next page. Connect to a back up oxygen source and call your home care provider if your troubleshooting actions fail to end this alert condition. |
| Yellow LED illuminates continuously. The Red LED is off and the Audible Alarm is silent. | The device has detected a low oxygen condition (OPI units only). | Continue using the unit but call your home care provider about this condition. |

Troubleshooting Guide

| Problem | Why it Happened | What to Do |
|---|--|---|
| Yellow LED is blinking. The Red LED is off and the Audible Alarm is beeping periodically. | The device has detected a high oxygen flow condition. | Turn the flow rate down to your prescribed level. Wait at least 2 minutes. If the condition persists turn the unit off, connect to a back up oxygen source, and call your home care provider. |
| Green LED illuminates continuously. The other LEDs are off and the Audible Alarm is silent. | The device is turned on and working properly. | Take no action. |
| The device is not working when it is turned on. (The Audible Alarm is sounding continuously. All LEDs are off.) | The power cord plug is not properly inserted into the electrical outlet. | Make sure the device is properly plugged in to the electrical outlet. |
| | The unit is not receiving power from the electrical outlet. | Check your household outlet fuse or circuit. |
| | Internal part failure. | Connect to a back up oxygen source and contact your home care provider. |
| The device is not working when it is turned on. (The Audible Alarm is sounding continuously and all 3 LEDs are illuminated.) | Internal part failure. | Connect to a back up oxygen source and contact your home care provider. |
| Impeded oxygen flow indication is activated. (The Yellow LED illuminates continuously, the Red LED is blinking and the Audible Alarm is beeping periodically.) | The airflow to the device is impeded or blocked. | Remove any items that appear to be blocking the airflow into the device. |
| | The flow meter knob is completely closed. | Turn the flow meter knob counterclockwise to center the ball on the prescribed LPM flow. |
| | The oxygen tubing is kinked and blocking the delivery of oxygen. | Check to see that the tubing is not kinked or blocked. Replace if necessary. |
| Limited oxygen flow to the user without any fault indication. (All LEDs are off and the Audible Alarm is silent.) | The oxygen tubing or cannula is faulty. | Inspect and replace the items if necessary. |
| | There is a poor connection to a device accessory. | Ensure that all connections are free from leaks. |

Chapter 5: Specifications

Environmental

| | Operating | Transport & Storage |
|--------------------------|--------------------------|--------------------------|
| Temperature | 13 to 32°C | -34 to 71°C |
| Relative Humidity | 15 to 95%, noncondensing | 15 to 95%, noncondensing |
| Altitude | 0 to 2286 m | N/A |

Physical

| | |
|-------------------|-----------------------|
| Dimensions | 58 cm x 38 cm x 24 cm |
| Weight | 14 to 15 kg |

Standards Compliance

This device is designed to conform to the following standards:

- IEC 60601-1 Medical Electrical Equipment, Part 1: General Requirement for Safety
- IEC 60601-1-2 2nd edition, Medical Electrical Equipment, Part 1-2: General Requirement for Safety – Collateral Standard: Electromagnetic Compatibility – Requirements and Tests.
- ISO 8359 Oxygen Concentrators for Medical Use – Safety Requirements

Electrical, AC Power Consumption

| | |
|---|-----------------------------|
| Models 1020000, 1020001 1020002, 1020003 1020014, 1020015 | 120 VAC ±10%, 350 W, 60 Hz |
| 1020004, 1020005 | 230 VAC ±10%, 320 W, 60 Hz |
| 1020006, 1020007, 1020008 1020009, 1020010 1020011, 1020012 1020016, 1020017 | 230 VAC ±10%, <300 W, 50 Hz |
| 1020013 | 230 VAC ±10%, <300 W, 60 Hz |

Oxygen

| | |
|---|--------------------------|
| Oxygen Concentration* (All Models except 1020007, 1020008) | 90-96% from 0.5 to 5 LPM |
| Models 1020007, 1020008 | 87-96% from 0.5 to 5 LPM |

* Device operation above or outside of the voltage, LPM, temperature, humidity and/or altitude values specified may decrease oxygen concentration levels.

Sound Level

| | |
|---|-----------------|
| Models 1020000, 1020001 1020002, 1020003 1020013 | 45 dBA typical |
| 1020004, 1020005 1020006, 1020008 1020009, 1020010 1020011, 1020012 1020016, 1020017 | 43 dBA typical |
| 1020007, 1020014 1020015 | <40 dBA typical |

Classification

The EverFlo / EverFlo Q Oxygen Concentrator is classified as:

- IEC Class II Equipment
- Type BF Applied Part
- IPX1 Drip Proof
- Not suitable for use in the presence of a flammable anesthetic mixture with air or with oxygen or nitrous oxide.
- Continuous Operation

Disposal

Dispose of the device in accordance with local regulations.

WEEE/RoHS Recycling Directives

If you are subject to the WEEE/RoHS recycling directives, refer to www.respironics.com for the passport for recycling this product.

Appendix A: EMC Information

GUIDANCE AND MANUFACTURER'S DECLARATION – ELECTROMAGNETIC EMISSIONS: This device is intended for use in the electromagnetic environment specified below. The user of this device should make sure it is used in such an environment.

| EMISSIONS TEST | COMPLIANCE | ELECTROMAGNETIC ENVIRONMENT – GUIDANCE |
|---|------------|---|
| RF emissions CISPR 11 | Group 1 | The device uses RF energy only for its internal function. Therefore, its RF emissions are very low and are not likely to cause any interference in nearby electronic equipment. |
| RF emissions CISPR 11 | Class B | The device is suitable for use in all establishments, including domestic establishments and those directly connected to the public low-voltage power supply network. |
| Harmonic emissions IEC 61000-3-2 | Class A | |
| Voltage fluctuations/Flicker emissions IEC 61000-3-3 | Complies | |

GUIDANCE AND MANUFACTURER'S DECLARATION – ELECTROMAGNETIC IMMUNITY: This device is intended for use in the electromagnetic environment specified below. The user of this device should make sure it is used in such an environment.

| IMMUNITY TEST | IEC 60601 TEST LEVEL | COMPLIANCE LEVEL | ELECTROMAGNETIC ENVIRONMENT – GUIDANCE |
|--|---|---|--|
| Electrostatic Discharge (ESD) IEC 61000-4-2 | ±6 kV contact ±8 kV air | ±6 kV contact ±8 kV air | Floors should be wood, concrete or ceramic tile. If floors are covered with synthetic material, the relative humidity should be at least 30%. |
| Electrical Fast Transient/Burst IEC 61000-4-4 | ±2 kV for power supply lines ±1 kV for input-output lines | ±2 kV for supply mains ±1 kV for input/output lines | Mains power quality should be that of a typical home or hospital environment. |
| Surge IEC 61000-4-5 | ±1 kV differential mode ±2 kV common mode | ±1 kV differential mode ±2 kV for common mode | Mains power quality should be that of a typical home or hospital environment. |
| Voltage dips, short interruptions and voltage variations on power supply input lines IEC 61000-4-11 | <5% U_T (>95% dip in U_T) for 0.5 cycle 40% U_T (60% dip in U_T) for 5 cycles 70% U_T (30% dip in U_T) for 25 cycles <5% U_T (>95% dip in U_T) for 5 sec | <5% U_T (>95% dip in U_T) for 0.5 cycle 40% U_T (60% dip in U_T) for 5 cycles 70% U_T (30% dip in U_T) for 25 cycles <5% U_T (>95% dip in U_T) for 5 sec | Mains power quality should be that of a typical home or hospital environment. If the user of the device requires continued operation during power mains interruptions, it is recommended that the device be powered from an uninterruptible power supply or a battery. |
| Power frequency (50/60 Hz) magnetic field IEC 61000-4-8 | 3 A/m | 3 A/m | Power frequency magnetic fields should be at levels characteristic of a typical location in a typical hospital or home environment. |

Note: U_T is the a.c. mains voltage prior to application of the test level.

GUIDANCE AND MANUFACTURER'S DECLARATION – ELECTROMAGNETIC IMMUNITY: This device is intended for use in the electromagnetic environment specified below. The user of this device should make sure it is used in such an environment.

| IMMUNITY TEST | IEC 60601 TEST LEVEL | COMPLIANCE LEVEL | ELECTROMAGNETIC ENVIRONMENT – GUIDANCE |
|---|-----------------------------|------------------|---|
| Conducted RF IEC 61000-4-6 | 3 Vrms 150 kHz to 80 MHz | 3 Vrms | Portable and mobile RF communications equipment should be used no closer to any part of the device, including cables, than the recommended separation distance calculated from the equation applicable to the frequency of the transmitter. Recommended separation distance: $d = 1.2 \sqrt{P}$ 150 kHz to 80 MHz $d = 1.2 \sqrt{P}$ 80 MHz to 800 MHz $d = 2.3 \sqrt{P}$ 800 MHz to 2.5 GHz Where P is the maximum output power rating of the transmitter in watts (W) according to the transmitter manufacturer and d is the recommended separation distance in meters (m). Field strengths from fixed RF transmitters, as determined by an electromagnetic site survey ^a , should be less than the compliance level in each frequency range ^b . Interference may occur in the vicinity of equipment marked with the following symbol:  |
| Radiated RF IEC 61000-4-3 | 3 V/m 80 MHz to 2.5 GHz | 3 V/m | |
| <p>Note 1: At 80 MHz and 800 MHz, the higher frequency range applies.</p> <p>Note 2: These guidelines may not apply in all situations. Electromagnetic propagation is affected by absorption and reflection from structures, objects, and people.</p> <p>a: Field strengths from fixed transmitters, such as base stations for radio (cellular/cordless) telephones and land mobile radios, amateur radio, AM and FM radio broadcast and TV broadcast cannot be predicted theoretically with accuracy. To assess the electromagnetic environment due to fixed RF transmitters, an electromagnetic site survey should be considered. If the measured field strength in the location in which the device is used exceeds the applicable RF compliance level above, the device should be observed to verify normal operation. If abnormal performance is observed, additional measures may be necessary, such as re-orienting or relocating the device.</p> <p>b: Over the frequency range 150 kHz to 80 MHz, the field strengths should be less than 3 V/m.</p> | | | |

RECOMMENDED SEPARATION DISTANCES BETWEEN PORTABLE AND MOBILE RF COMMUNICATIONS EQUIPMENT AND THIS DEVICE:

The device is intended for use in an electromagnetic environment in which radiated RF disturbances are controlled. The customer or the user of this device can help prevent electromagnetic interference by maintaining a minimum distance between portable and mobile RF communications equipment (transmitters) and this device as recommended below, according to the maximum output power of the communications equipment.

| RATED MAXIMUM POWER OUTPUT OF TRANSMITTER (W) | SEPARATION DISTANCE ACCORDING TO FREQUENCY OF TRANSMITTER (m) | | |
|---|---|---|--|
| | 150 kHz to 80 MHz $d = 1.2 \sqrt{P}$ | 80 MHz to 800 MHz $d = 1.2 \sqrt{P}$ | 800 MHz to 2.5 GHz $d = 2.3 \sqrt{P}$ |
| 0.01 | 0.12 | 0.12 | 0.23 |
| 0.1 | 0.38 | 0.38 | 0.73 |
| 1 | 1.2 | 1.2 | 2.3 |
| 10 | 3.8 | 3.8 | 7.3 |
| 100 | 12 | 12 | 23 |
| <p>For transmitters rated at a maximum output power not listed above, the recommended separation distance (d) in meters (m) can be estimated using the equation applicable to the frequency of the transmitter, where P is the maximum output power rating of the transmitter in watts (W) according to the transmitter manufacturer.</p> <p>Note 1: At 80 MHz and 800 MHz, the separation distance for the higher frequency range applies.</p> <p>Note 2: These guidelines may not apply in all situations. Electromagnetic propagation is affected by absorption and reflection from structures, objects, and people.</p> | | | |

Limited Warranty

Respironics, Inc. warrants that the system shall be free from defects of workmanship and materials and will perform in accordance with the product specifications for a period of three (3) years from the date of sale by Respironics, Inc. to the dealer. Respironics warrants that the EverFlo / EverFlo Q units serviced by Respironics, or an authorized service center, will be free from defects in serviced materials for a period of 90 days and free from defects in workmanship for a period of 90 days from the time of service. Respironics accessories are warranted to be free of defects in materials and workmanship for a period of 90 days from the time of purchase. If the product fails to perform in accordance with the product specifications, Respironics, Inc. will repair or replace – at its option – the defective material or part. Respironics, Inc. will pay customary freight charges from Respironics, Inc. to the dealer location only. This warranty does not cover damage caused by accident, misuse, abuse, alteration, and other defects not related to material or workmanship.

Respironics, Inc. disclaims all liability for economic loss, loss of profits, overhead, or consequential damages which may be claimed to arise from any sale or use of this product. Some states do not allow the exclusion or limitation of incidental or consequential damages, so the above limitation or exclusion may not apply to you.

This warranty is given in lieu of all other express or implied warranties, including the implied warranties of merchantability and fitness for a particular purpose. In addition, in no event shall Respironics be liable for lost profits, loss of good will, or incidental or consequential damages, even if Respironics has been advised of the possibility of the same. Some states or provinces do not allow the exclusion of limitation of implied warranties or the disclaimer of incidental and consequential damages. Accordingly, the laws of your state or province may give you additional protections.

To exercise your rights under this warranty, contact your local authorized Respironics, Inc. dealer or contact Respironics, Inc. at:

Respironics
1001 Murry Ridge Lane
Murrysville, PA 15668
USA
1-724-387-4000

Respironics Deutschland
Gewerbstrasse 17
82211 Herrsching
Germany
+49 8152 93060